

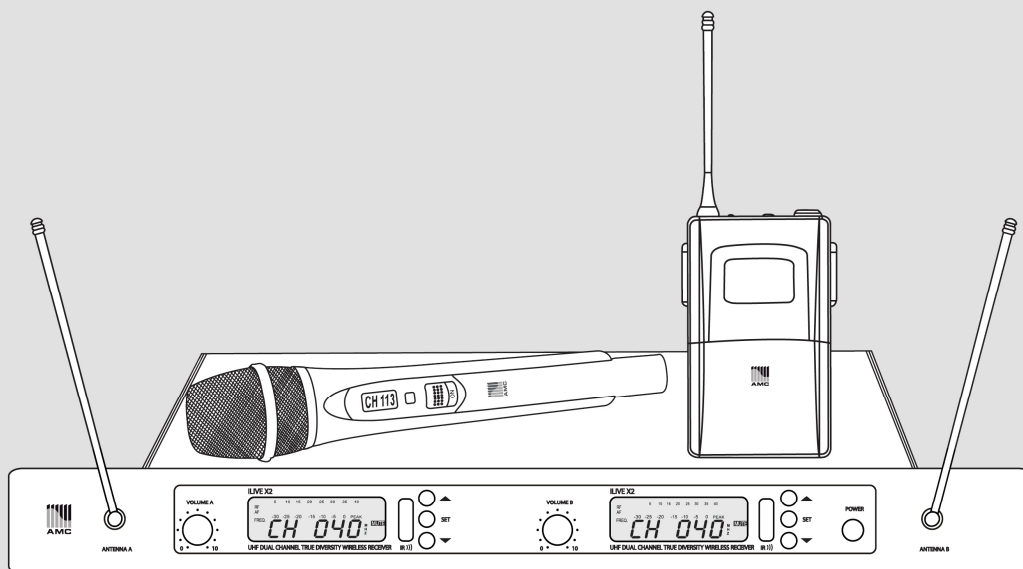

iLive X2 UHF WIRELESS SYSTEM



User Manual

iLive X2 – one of the latest wireless microphones systems of the AMC iLive series. This system is created for active musicians and presenters who also manage their own sound. iLive X2 improves your performance and simplifies your setup. iLive X2 - dual wireless microphone system which delivers the crystal clear sound quality that pro audio engineers trust.

CONTENTS:

Wireless system features	3
Product Introduction	3
System components	4
Front panel	4
Rear panel	5
Receiver LCD Instruction	5
Handheld transmitter	6
Handheld transmitter LCD instruction	6
Body pack transmitter	7
Body pack transmitters LCD instruction	7
Lavalier microphone	8
Headset microphone	8
System settings	9
Receiver setup	9
Handheld microphone setup	10
Body Pack Transmitter setup	11
Operation	12
Troubleshooting	13
Batteries installation	14
Specifications	16

Product Introduction

The iLive X2 dual wireless microphone system is adopted by UHF frequency transmission. This system is controlled by mini CPU control which enhances the frequency more stable. The working range is 795MHz~820MHz where programmed 100 frequency combinations make the channels interchangeable. Advanced audio and noise lock by dual mute control technology avoids the interruption from any noise signal. The anticipated decline function of CPU settles the weakness of interval break at the audio output from working distance of receiver. In this dual wireless microphone are integrated Infrared Automatic Channel Targeting system, locking function, High and Low modes power's transmitter. The main body provides two separated balance outputs of each microphones and one mixed unbalanced output. These outputs allow very conveniently connect this microphone with mixers or amplifiers. In this handheld microphone is installed unique software program which controls power-on and power-off. No matter in what situation the whole system is, there is no shock from accidentally power-on and power-off, and therefore the safety of post amp and speakers is ensured.

4 Wireless System Features

System components

All system includes:

- ❶ Receiver 1 pc.
- ❷ 1/4 jack audio connecting cable..... 1 pc.
- ❸ Power supply 1 pc.
- ❹ Antennas 2 pc.
- ❺ User manual 1 pc.

Front panel

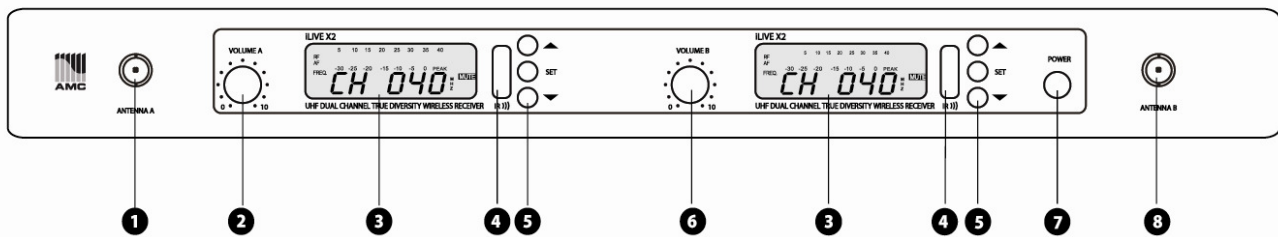

- ❶ A antenna connector
- ❷ Volume control for microphone A
- ❸ LCD display
- ❹ Infrared automatic frequency window
- ❺ Function Buttons
- ❻ Volume control for microphone B
- ❼ Power on/off Switch
- ❽ B antenna connector

5 Wireless System Features

Rear panel

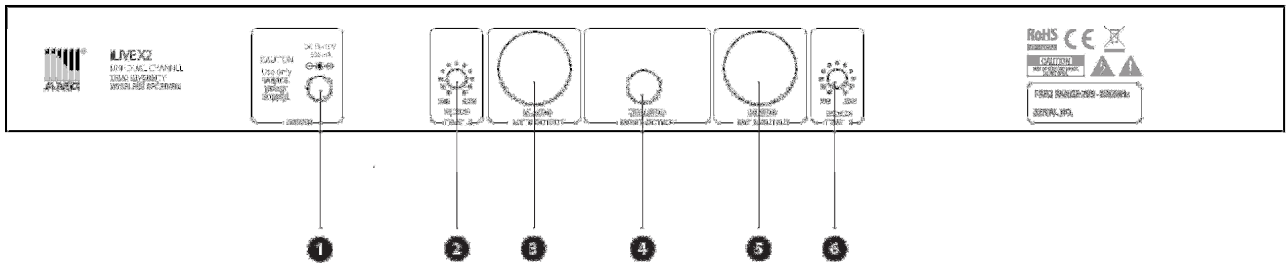

- ❶ DC power socket
- ❷ Output A squelch level control
- ❸ Microphone A audio output
- ❹ Mixed audio output
- ❺ Microphone B audio output
- ❻ Output B squelch level control

Receiver LCD Instruction

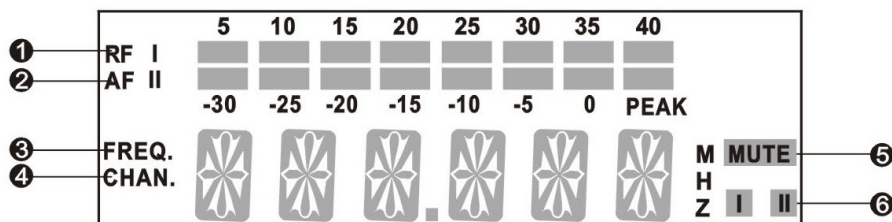

- ❶ 8-degree RF level display: to display the strength of the received RF signal.
- ❷ 8-degree Audio level display: to display audio signals.
- ❸ Frequency menu display: If FREQ lights, then the latter six characters display the current operating frequency.
- ❹ Channel menu display: If CHAN lights, then the display is indicating the current operating channel.
- ❺ Mute display: When MUTE lights, then the display is indicating that no radio signals is being received.
- ❻ Channel display: dynamically display the current operating channel.

6 Wireless System Features

Handheld transmitter

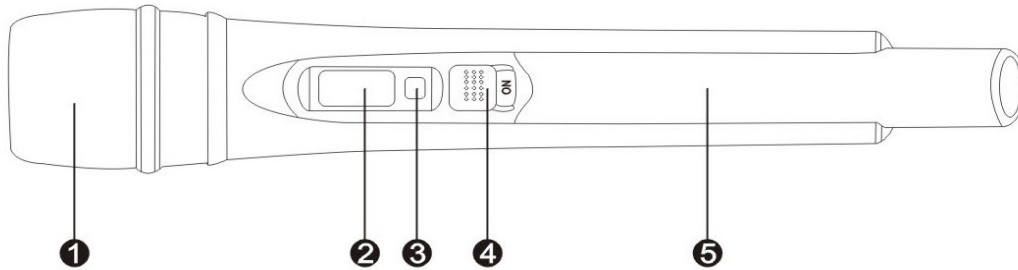

- ❶ Sound inlet basket
- ❷ LCD display
- ❸ IR port : receives infrared beam to synchronize frequencies
- ❹ Power on /off/mute switch
- ❺ Microphone body

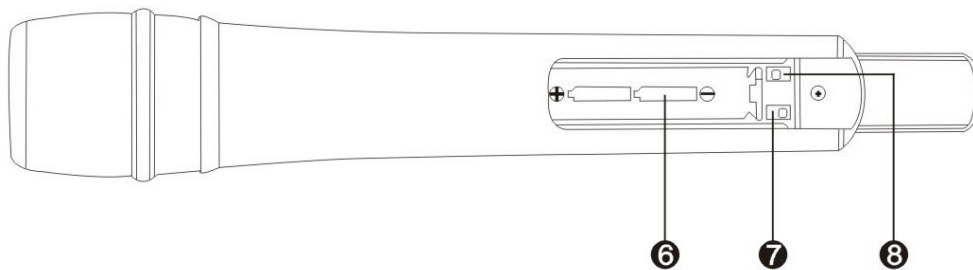

- ❻ Battery port: 2*1,5 AA Alkaline batteries
- ❼ LOW and HIGH power's RF switch
- ❽ LOCK switch

Handheld transmitter LCD instruction

- ❶ The 3 digits display shows the channel's number
- ❷ 8-step level display shows battery level

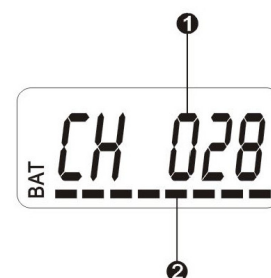

Body Pack Transmitter

- ❶ 4 pin Microphone Input Jack
- ❷ On-Off switch
- ❸ Low battery indicator: After transmitters power on, this indicator will be blink for a one time. This blink indicates that the device is enabled and the batteries condition is good. If this indicator starts light all the time it means that the battery capacity is to low and needs to be replaced.
- ❹ Antenna: flexible, 1/4 wave length transmitting antenna
- ❺ Belt clip
- ❻ LCD Display: Displays current active channel and battery status
- ❼ IR port: receives infrared beam to synchronize frequencies
- ❽ Battery port for 2*1,5 AA Alkaline batteries
- ❾ Function Buttons: SET, "▲" / "▼"
- ❿ High and low RF power transformation switch

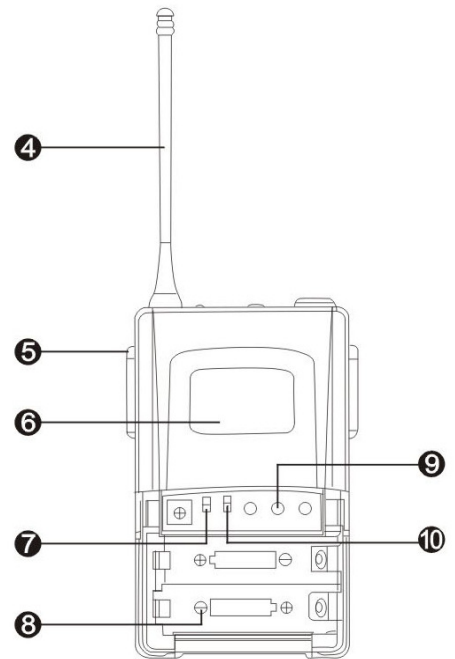
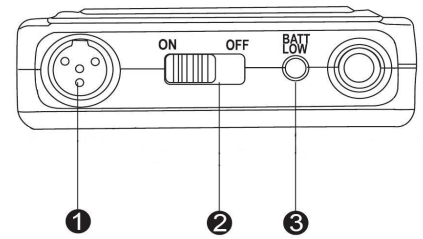

Body Pack Transmitter's LCD instruction

- ❶ Channel's number or working frequency display.
- ❷ 8-step level display shows battery level.



Lavalier microphone

- ❶ Microphone
- ❷ Microphone clip
- ❸ Mini XLR
- ❹ Microphone windscreen

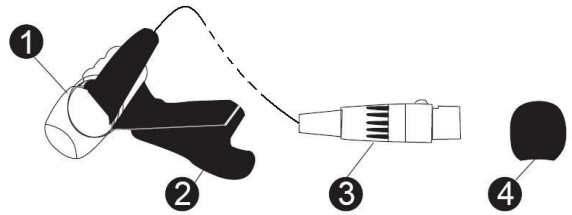

Before use please, fix Lavalier microphone to the lapel or tie where suitable place for sound pick-up is. Plug the mini XLR into the microphone input on body pack transmitter. Now you can start using this device.

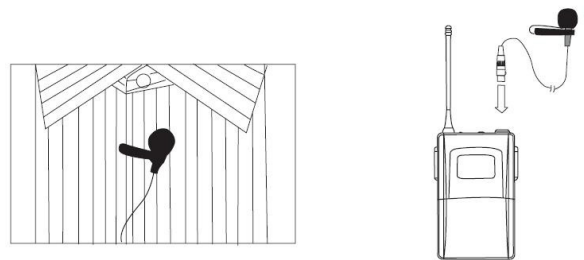

Headset microphone

- ❶ Microphone
- ❷ Gooseneck
- ❸ Neck - frame
- ❹ Mini XLR

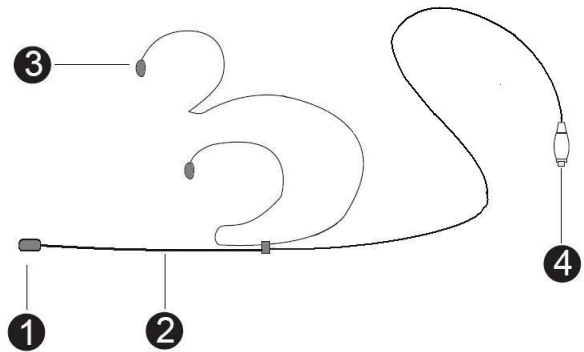

Before use please, put the neck frame behind your neck and fix about 2 – 5cm distance between mouth and microphone. Plug the mini XLR into the microphone input on body pack transmitter. Now you can start using this device.

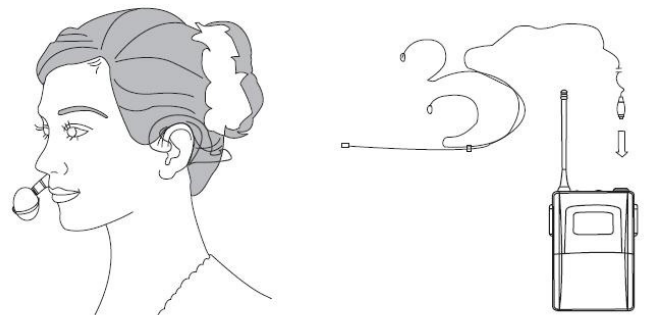

Receiver setup

1. Before turning on the receiver, please turn off the transmitters and turn the receiver's volume knobs down to the smallest volume.
2. If you want turn on/off the receiver, please push the POWER button for 3 seconds.
3. After transmitters turning on, the corresponding RF level will be illuminated on the LCD. Now you can adjust receiver's volume to a proper level and make some sounds towards microphone. During this, receiver's audio level meter should illuminate signal of your voice. If audio output or RF level meters are not illuminated, please examine the device.
4. If RF or audio signals level meters show signals unstable, please change the receiver channel. Maybe interference causes is the problem. If you want to avoid the unstable work, don't use both microphones in the same channel at one time.
5. Press SET button to select the main menu one by one in a cycle. Press " ^ " or " v " buttons to change the current state of the selected menu. Hold the " ^ " or " v " button for a long time to quickly select the frequency or channel. After parameters' changes, LCD screen will be flashing as a reminder in 2-3 seconds, and the flashing will be stopped after pressing SET button one more time. After this procedure your settings will be confirmed.
6. For Automatic Frequency Operation press SET button. After pressing, main display became as in the picture1. Target transmitter IR port in to receiver's infrared automatic frequency window and hold it for 2-3 seconds. Receiver's channel parameters shall be sent to transmitters via infrared data.

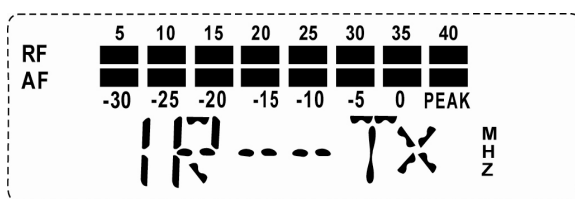

Picture 1

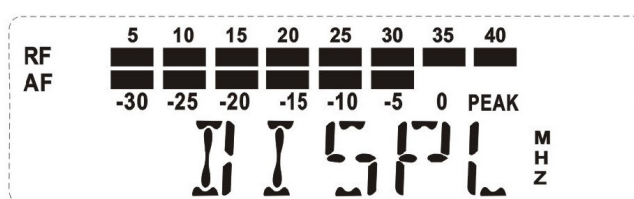

Picture 2

7. For the main display settings press the SET button several times until LCD screen becomes like in picture 2. You can change LCD display by pressing " ^ " or " v ". If you choose "CHANNEL", then you will see channel number on the main display field. If you choose "FREQU", then you will see the actual working frequency on the main display. After settings, please press SET button again for the confirmation.

8. For the System Locking Control press the SET button for several times until you will see the LCD screen as in picture 3.

After 2-3 seconds the pictures, "LOC ON" or "LOC OFF" will appear on the position of "LOCK". LOCK status can be changed by pressing " ^ " or " v " buttons.

After changes please push SET button one more time to confirm the settings. (Note: This Control function is for locking receiver's current working status. If the locked state is "LOC ON", it is unable to change the current operating status, if it is the non -locked state "LOC OFF" , all the menu functions can be changed.)

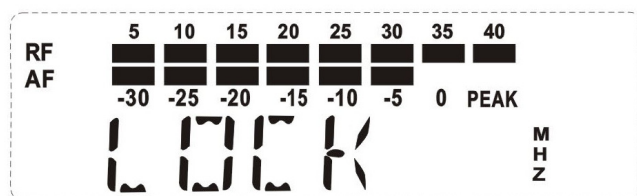

Picture 3

Handheld microphone setup

1. Before starting, please open the battery cover and insert 2AA alkaline batteries.
2. Slide the transmitter ON/MUTE/OFF switch to the ON position. LCD displays the CHANNEL and BATTERY LEVEL.
3. If you want to change the active channel, you need to change the channel into the receiver and set receivers menu status as in picture1. After this, target transmitter's IR port in to receiver's infrared automatic frequency window, after couple seconds channel will be changed.
4. Slide the transmitter ON/MUTE/OFF switch to the MUTE position, if the wireless system should be used in silent mode. Please note that the microphone is still consuming power when it is muted.
5. If " Lo bat" text appears in the microphone display, it shows that the battery is low and needs to be replaced.
6. When you are finished using the transmitter, switch off the power source. Remove the batteries when storing for long time.

Body Pack Transmitter setup

1. Before starting, please open the battery cover and insert 2AA alkaline batteries.
2. Slide the transmitter ON/OFF switch to the ON position. LCD displays the CHANNEL and BATTERY LEVEL.
3. If you want to change the active channel, you need to change the channel into the receiver and set receivers menu status as in picture1. After this, target transmitter's IR port in to receiver's infrared automatic frequency window, after couple seconds channel will be changed.
4. For the transmitter locking control press the SET button for several times until text "Lod set" appears on the LCD screen.
After 2 -3 seconds, "LOC ON" or "LOC OFF " will appear on the display. LOCK status can be changed by pressing " ^ " or " v " buttons. After changes please push SET button one more time to confirm the settings.
5. You can control transmitters input gain by adjusting "GAIN" potentiometer. Input gain knob you can find near IR port in the body pack transmitter.
6. If you want you can set transmitters RF power. If you set RF power switch to "Lo" position transmitter power consumption became smaller. In this case battery's life became longer, but working distance became smaller. If you set RF power switch to "Hi" position transmitter power consumption became higher and working distance became higher too. Life of batteries became shorten in this case.
7. If "Lo bat" text appears in the microphone display, and "BAT LOW" LED starts lighting all the time, it shows that the battery is low and needs to be replaced.
8. When you are finished using the transmitter, switch off the power source. Remove the batteries when storing for long time.

Operation

- 1.** Please choose non-intermodulation frequency setting. Usually 4-8 transmitters can be used at the same time within 25MHz bandwidth. If more sets of wireless microphones are needed, devices with other frequency band should be applied.
- 2.** There should be appropriate distance between the receiver and transmitter. Transmitter should be not too far and too near to the receivers.
- 3.** If receiving condition seems not to be as good as expected, extended cord, exterior high-gain antenna, and even antenna amplifier can be applied.
- 4.** The receiver and transmitter must be set at the same frequency channel.
- 5.** When several sets of receivers are used together, it is recommended to use high-gain antenna, antenna amplifier and receive branch unit.
- 6.** Barrier between transmitter and receiver should be as small as possible. The best situation is when signal from transmitter can reach receiver directly.
- 7.** When Receiver adopts the omni-directional antenna, please keep the antenna away from the wall, and also away from any other metal objects.
- 8.** The transmitters should be at least 20 cm apart when multiple transmitters are used together. It prevents interference to each other.
- 9.** If the transmitters are set in small power mode, you can use 100 transmitters at the same frequency band.
- 11.** When you use Handheld Microphone, please hold it in the middle of the microphone body. If you hold too close to the Microphone grille, it will affect the sound pick-up; if too close to the antenna (at the bottom of the microphone), transmission efficiency and working distance may be reduced.
- 12.** When system is not in application for a long period of time, please turn off the device and take off the battery.

Troubleshooting

Problem	Solution
No indication on receiver	Make sure AC adapter is securely plugged into electrical outlet and in to DC input connector on rear panel of receiver
Audio signal distortion, extra noise solutions	Remove the RF interference sources near by receiver and transmitter (such as CD players, computers, Digital devices, earphones monitoring system) Receivers and transmitters should be set at the same frequency. Change receivers squelch level. Make the distance smaller between receiver and transmitter.
No RF signal	Transmission frequency should be the same as the receiving frequency, or make sure the transmitter is not out of range.
RF signal available but no audio signal	Check microphone status. Maybe microphone power switch is on the mute position.
Unable to turn on transmitter	Replace transmitter batteries

14 Batteries installation

Handheld transmitter

1. Open the battery cover



2. Insert the 2*AA Alkaline battery

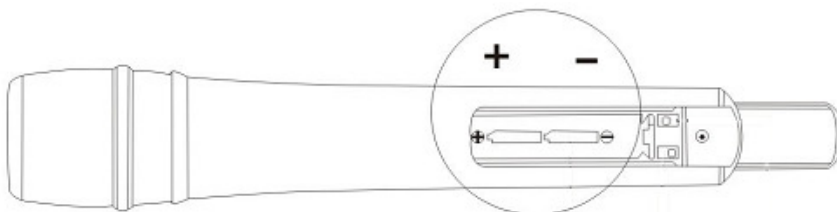

3. Close the battery cover

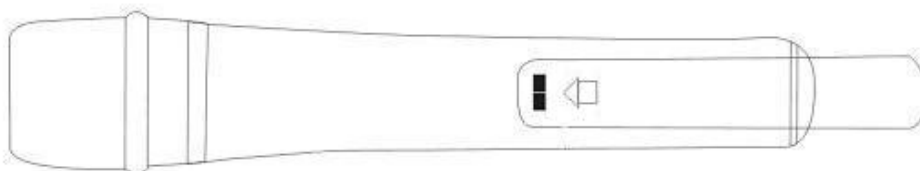

15 Batteries installation

Body pack transmitter

1. Open the battery cover

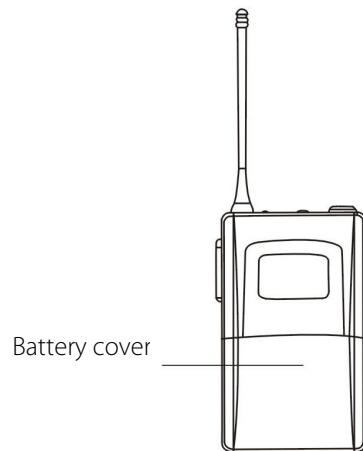

2. Insert the 2*1.5V AA Alkaline battery

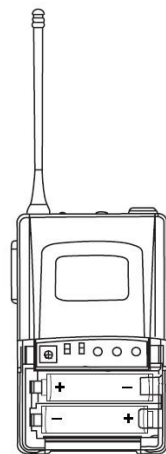

3. Close the battery cover

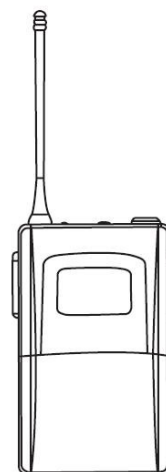

Receiver's specifications:

Carrier frequency range:	795-820 MHz
Modulation:	FM
Adjustable range:	25 MHz
Channels:	100
Channel spacing:	250 kHz
Frequency stability:	±0.005%
Dynamic range:	100 dB
Max. Deviation:	±45 kHz
Frequency response:	80 Hz-15 kHz (±3 dB)
S/N ratio:	>105 dB
T.H.D:	≤0.5%
Working range:	100 m (actual range depends on RF signal absorption, reflection, and interference)
Operating temperature range:	-10 °C - +40°C
Antenna:	BNC/50 Ω
Sensitivity:	20 dBV (80 dB S/N)
Image rejection:	≥70 dB
Max. Audio output:	+10 dB V